

# Evaluation of Platform Tilt

## BSEE Project Report

Contract Number 140E0119C0003

Aaron Bradshaw<sup>1</sup>

Isaac Scarborough<sup>2</sup>

*1 Professor, Department of Civil and Environmental Engineering, University Rhode Island, Kingston, RI  
02881*

*2 Undergraduate Student, Department of Ocean Engineering, University Rhode Island, Narragansett, RI  
02882*

July 2023

## TABLE OF CONTENTS

1.0 EXECUTIVE SUMMARY .....	3
2.0 DESCRIPTION OF TILTMETER .....	3
3.0 COORDINATE TRANSFORMATION.....	4
4.0 TILTMETER DATA QA/QC.....	5
5.0 EVALUATION OF PERMANENT PLATFORM TILT .....	10

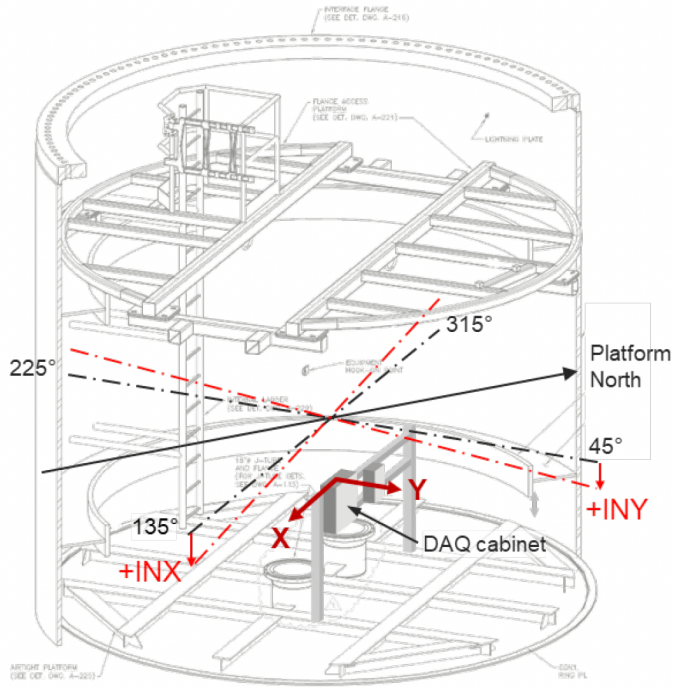
## **1.0 EXECUTIVE SUMMARY**

The BIWF turbine is subjected to lateral wind and waves loads which result in a cyclic vertical push-pull action on the supporting piles. The objective of this section is to perform a QA/QC on the tiltmeter data and assess the permanent tilt over the duration of the measurement campaign. The average tilt data suggests that the platform has tilted upwards of 0.25 degrees toward the east over the period of April 14, 2021 to September 26, 2022. Continued collection and analysis of the tilt data should be performed to assess longer term trends.

## **2.0 DESCRIPTION OF TILTMETER**

The tiltmeter consists of a dual axis inclinometer model VS-05-C-2-5 manufactured by Level Developments LTD. The sensor has an operating range of  $\pm 5$  degrees with a reported calibrated accuracy of  $\pm 0.02$  degrees at 20 degrees C and a resolution of 0.001 degrees.

The tiltmeter was mounted inside the DAQ cabinet which was then installed in the tower on April 2021 in the configuration shown in the drawing in Figure 1. The local tiltmeter coordinate system places the y-axis at 90 degrees clockwise from Magnetic North and the tilt sign conventions (+INX and +INY) are shown in Figure 1. Therefore, Magnetic North corresponds to the axis label of 315° in Figure 1.



**Figure 1. Tiltmeter axes and sign conventions as provided by NGL.**

### 3.0 COORDINATE TRANSFORMATION

To be consistent with the local coordinate system used in other sections of the report, the tiltmeter data were transformed to a local coordinate system called  $u$  and  $v$ , where  $v$  is in the direction of Magnetic North. To do this the following adjustments were made: (i) the tiltmeter coordinate system was rotated counterclockwise by 90 degrees, (ii) the signs were adjusted such that the rotations follow the right-hand-rule to be consistent with the moments, and (iii) an offset was included to ‘zero’ the sensor, resulting in the following equations:

$$\theta_u = INX \cos(90) + INY \sin(90) + \theta_{cu} \quad (1a)$$

$$\theta_v = INX \sin(90) - INY \cos(90) + \theta_{cv} \quad (1b)$$

where  $\theta_u$ =inclination about the x-axis,  $\theta_v$ =inclination about the y-axis,  $INX$ =measured inclination in the x-direction in the tiltmeter coordinate system (deg),  $INY$ =measured inclination in the y-

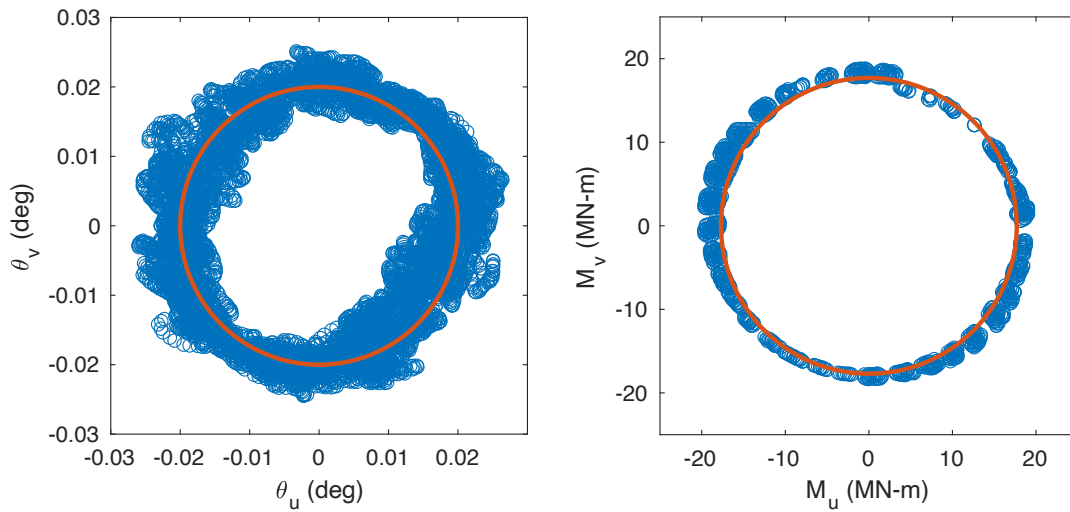
direction of the tiltmeter coordinate system,  $\theta_{cu}$ =zero offset in the u-direction, and  $\theta_{cv}$ =zero offset in the v-direction.

#### 4.0 TILTMETER DATA QA/QC

To ensure the validity of the tilt meter data, checks were made using the calibration exercise that took place on June 30, 2022 and described below.

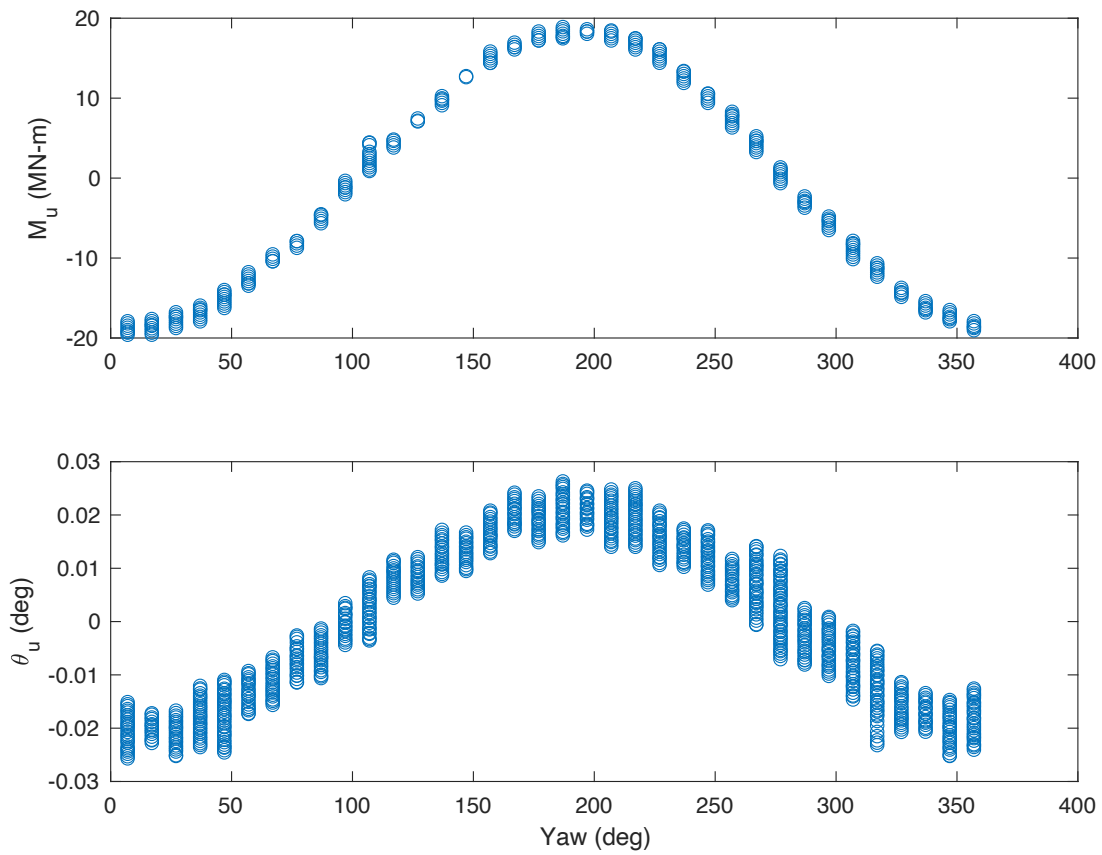
The nacelle has a center of gravity which is offset from the tower axis which therefore applies a static moment of 17.7 MN-m, taken as the product of the nacelle weight (430 metric tons) and the eccentricity (4.2 m). In the calibration exercise, GE technicians idled the turbine and then rotated and stopped the nacelle at 10-degree yaw increments over a full 360-degree rotation. The SCADA time and yaw angle was recorded in hand notes starting at 0 degrees at 13:19 hours. It was also observed from the hand-written notes that during the calibration exercise that the DAQ time display was 5 minutes behind the SCADA time display. It is important that these are synchronous as the SCADA data contains information about the yaw angle. Therefore, the strain gage and tilt data were selected at each 10-degree yaw angle from the DAQ at the same time as the SCADA data. This resulted in 501 data points per 10-degree yaw angle selected over a 10-second time window.

Figure 2 plots the tower base moments and rotations taken about the u and v axes. The tower base moments were calculated using the equations and zero offsets given in another section of the report. As shown in Figure 2, the data plots as circles as expected. Offset values of 0.336 and 0.026 were used to center the rotation data circle about the origin so that the tilt that is observed is a change due to the nacelle moment only. As compared to the moment data, there is more variability in the rotation data due to the lower accuracy of the tiltmeter at the magnitude of the rotations observed.

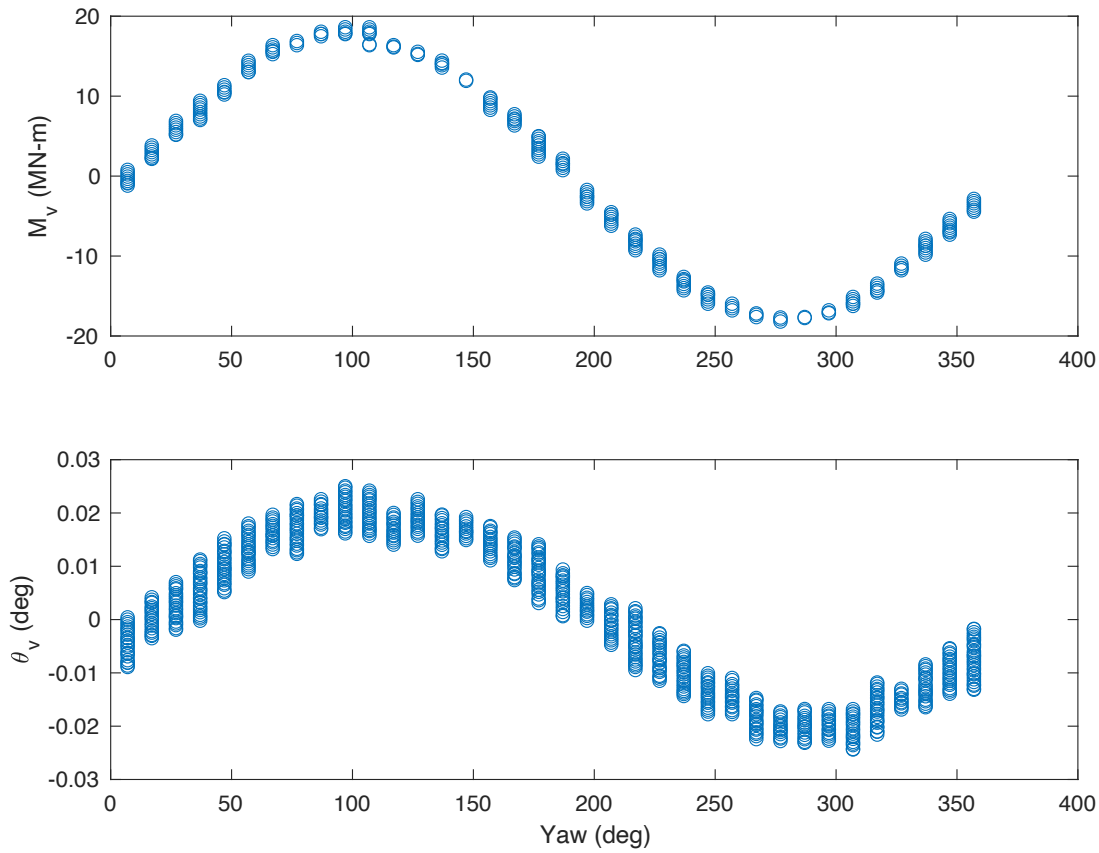


**Figure 2. Component plots for tower base rotation (left), and moment (right).**

The u- and v-components of the moment and rotations are plotted against yaw angle in Figures 3 and 4. As shown in these figures the applied moment and rotation are in phase; the platform is deflecting in the same direction as the applied moment.



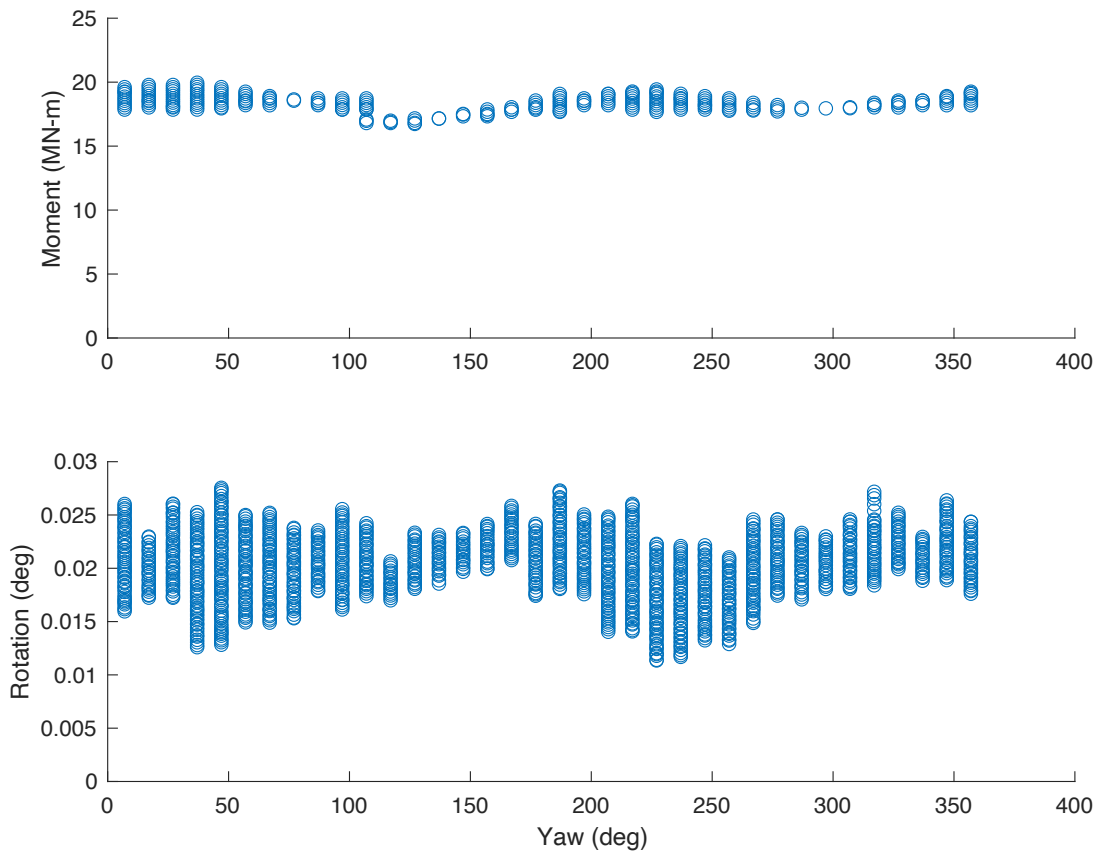
**Figure 3. Plot showing the u-component data for moment (top) and rotation (bottom).**



**Figure 4. Plot showing the v-component data for the moment (top) and rotation (bottom).**

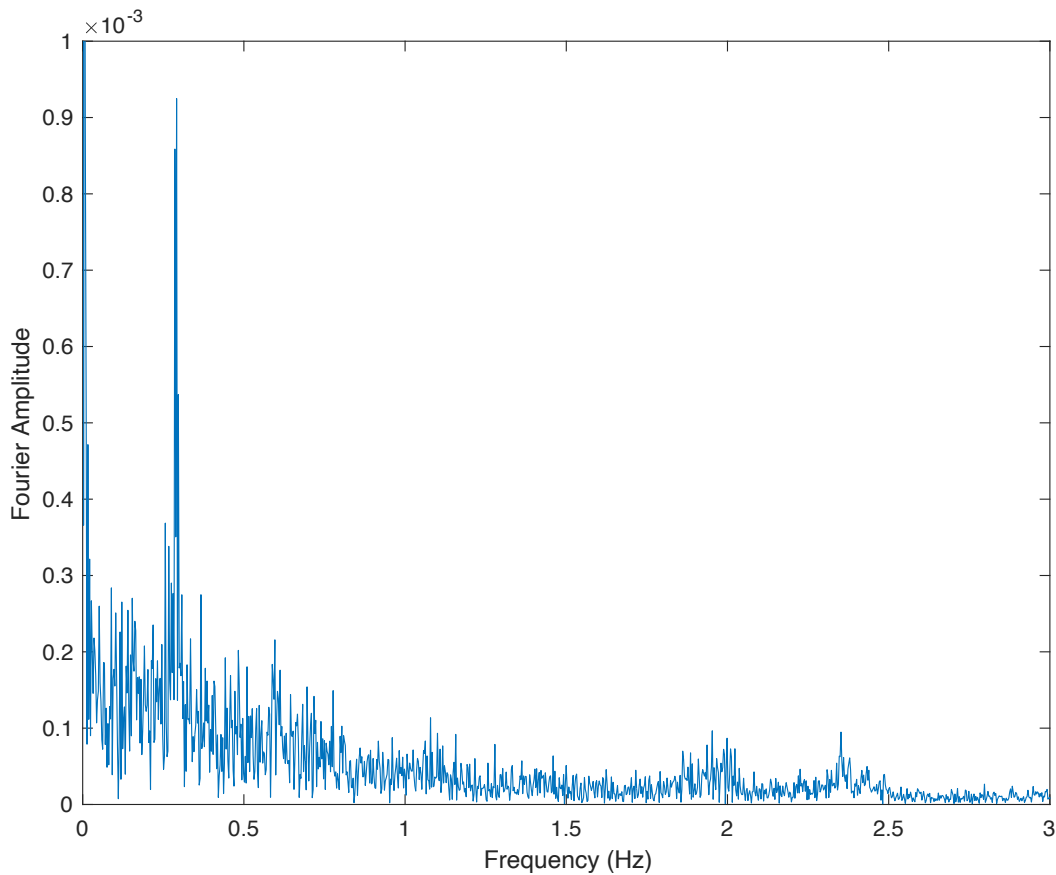
If the structure does not vibrate and there is no environmental forcing, then the magnitude of the moments and rotations should remain constant at all yaw angles. As shown in Figure 5, there was more variability centered around the 45-degree and 225-degree yaw directions suggesting that the platform was vibrating primarily in the North-Northeast direction during the calibration exercise. Data from an offshore buoy nearby (Station 44097) indicated that the primary wave direction was at 162 degrees, or from the South-Southeast. The wind direction from SCADA was -282 degrees (78 degrees) or from the East-Northeast.





**Figure 5. Magnitude of the moment (top), and rotation (bottom).**

The rotation data were processed to obtain a single sided Fourier Amplitude Spectrum (FAS). The results shown in Figure 6 show a significant spike around 0.29 Hz. As discussed in other section of the report, this is known to be the natural frequency of the first mode of vibration. This further suggests that the tiltmeter is picking up the first mode of vibration which may explain some of the variability in the rotation data presented above. There are also spikes around 2.0 Hz and 2.4 Hz suggesting that the tiltmeter may also be picking up higher modes of vibration, which is also discussed in other sections of the report.

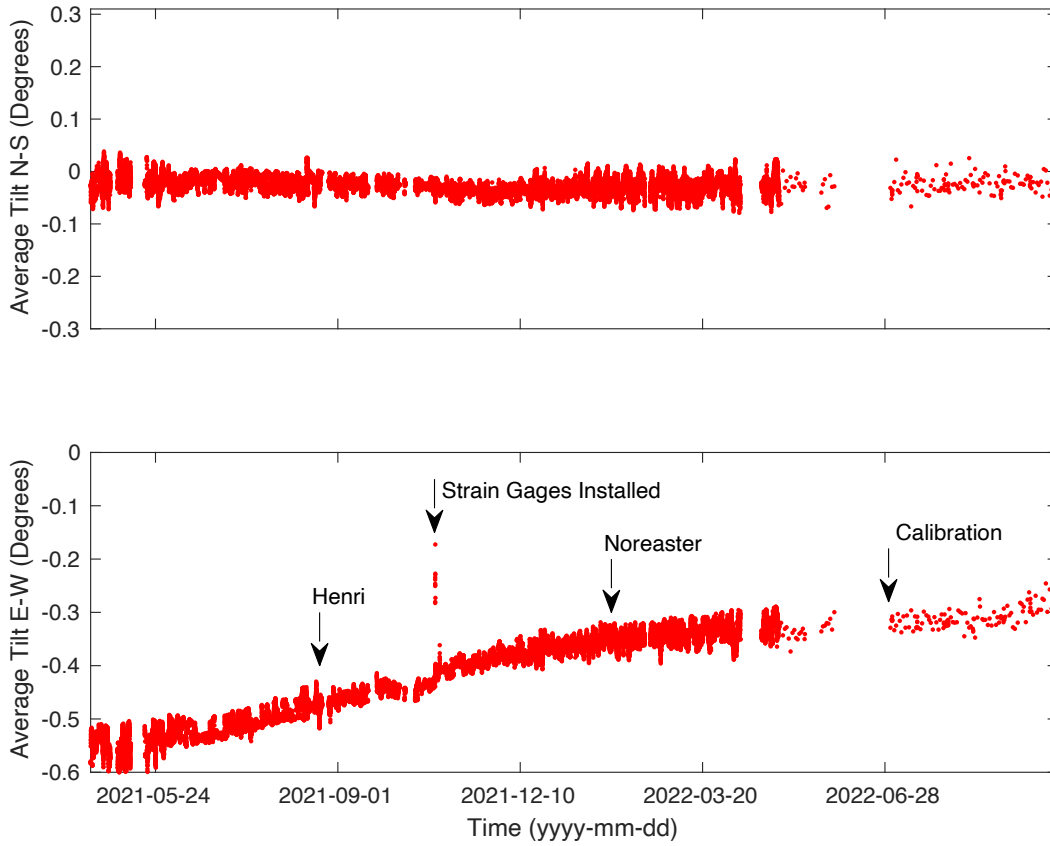


**Figure 6. Fourier Amplitude Spectrum of the tilt sensor data.**

## **5.0 EVALUATION OF PERMANENT PLATFORM TILT**

The tilt data were recorded continuously at a sampling frequency of 50Hz. The data were saved in files in 10-minute-long time segments consisting of 30,000 data points in each file. A Matlab program was developed that calls in each data file in chronological order and then calculates the average for the file. The average tilt data are plotted over time in Figure 7. The times of two key storm events including tropical storm Henri and a Nor'easter are also noted on the figure for reference. The tilt data suggests that the platform tilted gradually toward the east with a change of about 0.25 degrees over the period shown (April 14, 2021 to September 26, 2022). The rate of tilt appears to reduce after April 2022. Minimal permanent tilt was observed in the north-south direction. There did not appear to be any permanent shift or offset in the tilt data associated with the two major storm events (Henri or Nor'easter). The gradual permanent tilt is likely due to cyclic

accumulated displacement of the supporting piles, which is discussed in another section of the report. Continued collection and analysis of the tilt data should be performed to assess longer term trends.



**Figure 7. Observed average jacket tilt.**